

Dimensions KP-FD30

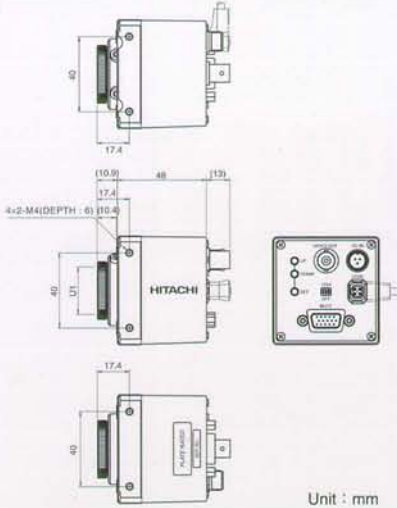

Unit : mm

Pin arrangement KP-FD30

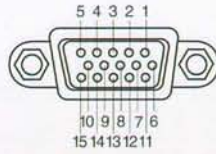

Unit : mm

High-Density 15pin connector plug:KEC-15p(Housing)

Pin No.	Signal	Pin No.	Signal	Pin No.	Signal
1	R/C OUT	6	VIDEO GND	11	GND
2	G/Y OUT	7	VIDEO GND	12	RXD
3	B/VBS OUT	8	VIDEO GND	13	HD IN/HD OUT/SYNC OUT
4	WE OUT	9	UNREG +12 V IN	14	VD IN/VD OUT
5	GND	10	TRIG IN	15	TXD

(Pin contact JK-SP2140)(Cover JK-C151C)

Lens connector (Plug:E4-191J-100)

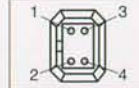

Pin No.	Signal
1	Damp ⊖
2	Damp ⊕
3	Drive ⊕
4	Drive ⊖

VIDEO optionally

12V IN connector (Plug:R03-P3F)

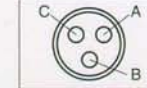

Pin No.	Signal
A	GND
B	+12 V IN
C	N.C.

Dimensions KP-FD30CL

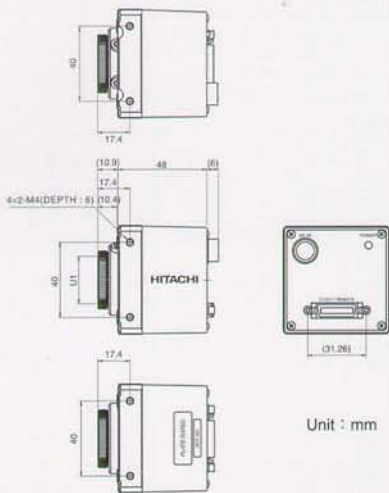

Unit : mm

Pin arrangement KP-FD30CL

DIGITAL OUT(Camera Link): connector 10226-5202JL(3M)

Pin no.	Symbol	Pin no.	Symbol
1	GND	14	GND
2	TXOUT 0 (-)	15	TXOUT 0 (+)
3	TXOUT 1 (-)	16	TXOUT 1 (+)
4	TXOUT 2 (-)	17	TXOUT 2 (+)
5	TXCLKOUT (-)	18	TXCLKOUT (+)
6	TXOUT 3 (-)	19	TXOUT 3 (+)
7	RX (+)	20	RX (-)
8	TX (-)	21	TX (+)
9	EXT-VD (-) [CC1 (-)]	22	EXT-VD (+) [CC1 (+)]
10	TRIG (+) [CC2 (+)]	23	TRIG (-) [CC2 (-)]
11	EXT-HD (-) [CC1 (-)]	24	EXT-HD (+) [CC1 (+)]
12	NC [CC4 (+)]	25	NC [CC4 (-)]
13	GND	26	GND

RX: Serial to Camera, TX: Serial to Frame Grabber

DC IN Plug HR10A-10P-12S(01)

Pin no.	Symbol
1	GND(+12V)
2	+12V
3	GND(Y)
4	MONITOR OUT
5	GND
6	---
7	---
8	GND(TRIG)
9	(TRIG IN)
10	GND(+12V)
11	+12V
12	GND

Standard Composition

Camera.....1
Operating manual.....1
C/CS mount adaptor.....1

Optional accessories

(1) Lens (see operating manual)
(2) DC input plug.....R03-P3F
(3) Lens plug.....E4-191J-100
(4) RGB cable(5m).....C501RR
(5) RGB cable(5m).....C501RR

KP-FD30 VGA System

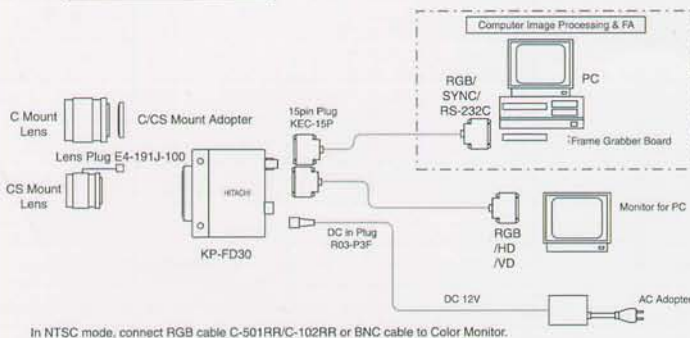

In NTSC mode, connect RGB cable C-501RR/C-102RR or BNC cable to Color Monitor.

KP-FD30CL System

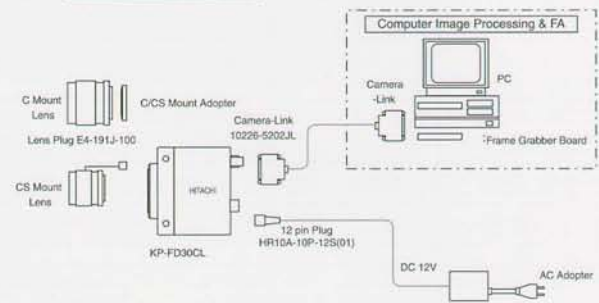

Hitachi Kokusai Electric Inc.

Head Office 14-20, Higashi-Nakano 3-chrome, Nakano-ku, Tokyo 164-8511, Japan
Phone : +81 (0) 3-3365-5928, Fax : +81 (0) 3-3365 5929
URL : www.h-kokusai.com

Hitachi Denshi (Europa) GmbH
Head office Weiskircher Straße 88, D-63110 Rodgau, Germany
Phone : +49 6106-69920, Fax : +49 6106-16906
URL : www.hitachi-denshi.de
General email address : webmaster@hitachi-denshi.de

Hitachi Denshi (Europe)
Leeds Office Brookfield House, Selby Road, Garforth, LEEDS, LS25 1NB, United Kingdom
Phone : +44 (0)113 287 4400, Fax : +44 (0)113 287 4260
URL : www.hitachi-denshi-uk.com
General email address : sales@hitachi-denshi-uk.com

Hitachi Denshi (UK) Limited
Head office Windsor House, Britannia Road, Waltham Cross, Hertfordshire, EN8 7NX, United Kingdom
Phone : +44 (0) 1992 704 595, Fax : +44 (0) 1992 704 599

These products are manufactured at a factory which has received quality control system certification in accordance with the ISO international standards.



CERTIFICATE No. JMI-0062
ISO 9001/BS 5750 Pt1
EN 29001/JIS 29901